

User Guide for Nokia Image Viewer SU-5

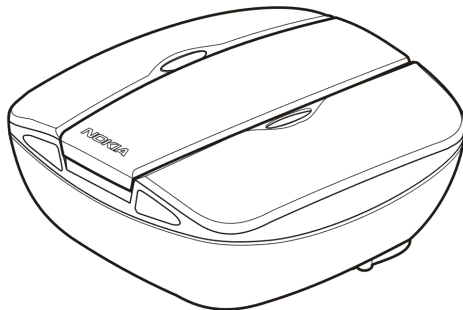

9356196

Issue 1

DECLARATION OF CONFORMITY

We, NOKIA CORPORATION, declare under our sole responsibility that the product SU-5 is in conformity with the provisions of the following Council Directive: 1999/5/EC. A copy of the Declaration of Conformity can be found at http://www.nokia.com/phones/declaration_of_conformity/.



Copyright © 2004 Nokia. All rights reserved.

Nokia, Nokia Connecting People and Pop-Port are trademarks or registered trademarks of Nokia Corporation. Other product and company names mentioned herein may be trademarks or tradenames of their respective owners.

Nokia operates a policy of continuous development. Nokia reserves the right to make changes and improvements to any of the products described in this document without prior notice. Nokia reserves the right to revise this document or withdraw it at any time without prior notice.

Under no circumstances shall Nokia be responsible for any loss of data or income or any special, incidental, consequential or indirect damages howsoever caused.

The availability of particular products may vary by region. Please check with the Nokia dealer nearest to you.

Contents

FOR YOUR SAFETY	4
Introduction	5
Technical data	5
1. Overview.....	8
2. Using the Nokia Image Viewer for the first time	12
Switching the power on and off	15
3. Using the Nokia Image Viewer	15
Nokia Image Viewer memory and picture formats	15
Before using the Nokia Image Viewer	16
Selecting the memory	17
Viewing images	18
Rotating images	19
Saving images.....	19
Deleting images	20
Care and maintenance	20

FOR YOUR SAFETY

Read these simple guidelines. Breaking the rules may be dangerous or illegal. Further detailed information is given in this manual.



QUALIFIED SERVICE

Only qualified personnel may repair the Nokia Image Viewer.



CONNECTING TO OTHER DEVICES

When connecting to any other device, read its user's guide for detailed safety instructions. Do not connect incompatible products.



WATER-RESISTANCE

Your Nokia Image Viewer is not water-resistant. Keep it dry.



IMPORTANT:

Do not point the IR (infrared) beam at anyone's eye or allow it to interfere with other IR devices. The remote control is a Class 1 Laser product.

CHARGERS AND BATTERIES

Check the model number of any charger before use with this device. The Nokia Image Viewer is intended for use with the following chargers: ACP-8, ACP-9 and ACP-12 and with standard AAA batteries.



Warning! Use only batteries and chargers approved by the manufacturer for use with this particular enhancement. The use of any other types will invalidate any approval or warranty applying to the enhancement, and may be dangerous.



IMPORTANT:

Only use chargers in dry conditions. Never connect the device to a power supply when the device or charger or their parts are damp or wet.

Never use any charger or battery which is damaged.

Do not short-circuit the batteries.

Do not dispose of batteries in a fire!

Dispose of batteries according to local regulations (e.g. recycling). Do not dispose as household waste.

Introduction

The Nokia Image Viewer SU-5 enables you to view a single picture or a set of pictures on a TV screen or compatible video projector. Nokia Image Viewer can display pictures that you have stored in a compatible phone or in an optional MMC card.

Read this user guide carefully before using the Nokia Image Viewer. More detailed information about phone features is provided in the user guide for your phone. Check your phone's guide for important safety and maintenance information. In addition, consult your TV's user guide for instructions on connecting external devices.

■ Technical data

- Weight with batteries: 220 g

- Measurements of the main unit:
 - Length: 95 mm
 - Width: 94 mm
 - Thickness: 48 mm
- Measurements of the remote control:
 - Length: 95 mm
 - Width: 33 mm
 - Thickness: 11 mm
- Operating time:
 - Main unit with AAA batteries: up to 2 hours (This is an estimate and applies to the batteries in the sales package. The operating time with any other batteries depends on the battery quality.)
 - Remote control with button battery: up to 50 weeks (used 3 times a week, 250 clicks a day)
- Operating temperature: -5°C to 55°C
- Compatibility with image display devices: The Nokia Image Viewer is compatible with the PAL and NTSC standards. You can also connect the Nokia Image Viewer to a compatible video projector through an AV connector. SECAM TV sets require a special adapter that is not supplied in the sales package. The SECAM adapter can be bought in an electrical supply store.
- Compatibility with phones: The Nokia Image Viewer is compatible with most Nokia MMS-enabled phones that have a Pop-Port™ connector. Via the MMC

card, the image viewer is compatible with the phones which have an MMC card (such as Nokia 9210 phone).

- Power supply: 4 AAA batteries, or Nokia ACP-8, ACP-9 or ACP-12 chargers





When connected to a charger, the Nokia Image Viewer does not use or recharge the batteries.

When using batteries as a power source, the Nokia Image Viewer automatically enters sleep mode after 10 minutes, if no control buttons have been pressed. When the batteries are running out of power, a low battery icon is displayed on the TV screen and the Nokia Image Viewer switches off after 3 minutes. You can wake up the Nokia Image Viewer by pressing any control button on the main unit or the remote control.

- Connection: fixed RCA connector for TV, fixed Pop-Port™ connector for phones, MMC card reader for the MMC card and an IR connection for the remote control.
- Supported image format: JPEG and GIF (not animated GIF)
- Supported image size: max 1600 * 1200 pixels
- Internal buffer size: 4.5 MB (Up to 150 images, size 30 kB each, can be stored while the Nokia Image Viewer is switched on. The maximum number of images depends on the image size, and all images in the buffer memory are lost when the power is switched off. Remember to make backup copies of all important data.)

1. Overview

The Nokia Image Viewer has the following parts:

1. Main unit
2. Remote control
3. Power on/off button 
4. Forward/Memory Change button 
5. Delete button 
6. Rotate/Slide Show button 
7. Save button 
8. Power status indicator light (red)





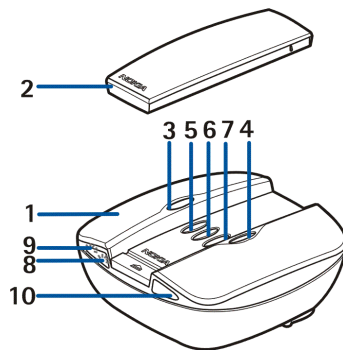

9. Charger indicator light (green)

The green light is shown when the Nokia Image Viewer uses the charger instead of the batteries as a power source.

10. IR port



The remote control has the following parts:

1. IR port
2. Rotate button 
3. Slide Show button 
4. Backward button 
5. Forward button 
6. Save button 
7. Memory Change button 
8. Delete button 

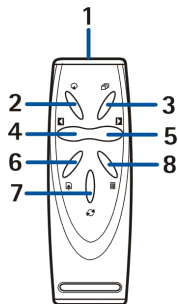

There are two ways to press the buttons.

- Press - press a button down and release immediately
- Press and hold - press and hold down a button for at least three seconds

Indicators on the display



Powering on/off



The Nokia Image Viewer could not find the default image folder in the phone.



The default image folder in the phone is empty.



Processing image



The MMC memory has been selected.



No MMC card inserted.



The phone memory has been selected.



The MMC card is full.



The MMC card is incompatible.



The Nokia Image Viewer has successfully saved an image or images to the MMC card.



If slide show not running, appears when slide show key pressed briefly.



The images in the slide show change every 4 seconds.



The images in the slide show change every 8 seconds.



Slideshow paused



The battery power level is low.



The battery power level is critical. Change the batteries or connect the Nokia Image Viewer to the charger.



Incompatible charger



Confirm delete - to delete hold the button for over three seconds



The image was successfully deleted from the Nokia Image Viewer or from the MMC card, depending on the selected memory.



An error occurred



Action successful

2. Using the Nokia Image Viewer for the first time

1. Open the main unit by pushing the release bar (1).

Note: Always switch the power off and disconnect the device from the charger or any other enhancement before opening the unit.

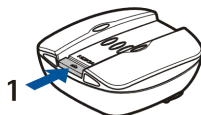

2. Lift the main unit cover up(2).



3. Unwrap the RCA connector cable from around the battery cover (3). Remove the battery cover by sliding it up as indicated by the arrow.

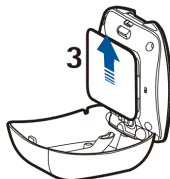

4. Insert the AAA batteries (4) and slide the cover back in place.
5. Check that the NTSC/PAL switch (5) is in the correct position.
6. Insert the MMC card (6) in the slot with the contact surface towards the top of the main unit (where the buttons are).
Lock the card in by pushing it in. To release the card, push it slightly in again.
7. Make sure that the RCA cable is in the provided notch (7) and close the main unit.

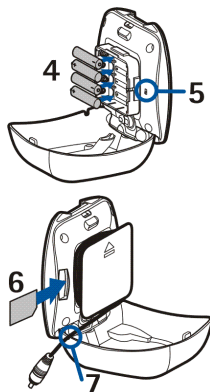

8. Install the remote control battery as shown in the picture below.

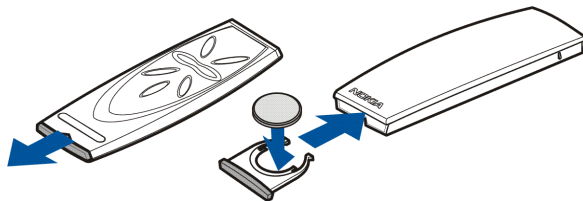

The Nokia Image Viewer remote control uses the provided CR2032 button battery as a source of power. If the remote control battery is out of power, you

can use the Nokia Image Viewer by pressing the control buttons on the main unit.

9. Connect the lead from the charger to the socket at the back of the Nokia Image Viewer and connect the charger to an AC wall socket.
10. Press and hold  on the main unit to switch on the Nokia Image Viewer.
11. Connect the RCA connector from the Nokia Image Viewer to a TV.

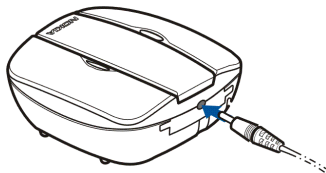

- If your TV does not have a RCA connector, you need a RCA/SCART adapter, which you can obtain from an electrical supply store. If you are using a wide screen TV set, the TV screen should be set to a 4/3 ratio.
12. Open the RCA input channel in the TV. The Nokia logo is shown on the TV screen when the correct channel is opened.
 13. Unwrap the Pop-Port™ connector from the bottom of the main unit and connect it to the compatible phone's Pop-Port™. Make sure that the phone is switched on.

A progress bar is displayed on the TV while the images are transferred from the phone. While the progress bar is displayed, pressing any of the buttons on the main unit or the remote control will have no effect. If no progress bar is shown, switch the phone off and then on again.

Note that after the Nokia Image Viewer has transferred the images in the phone to its own internal memory, you can disconnect the phone from the

Pop-Port™ and still continue to view the images. When you connect a phone to the Pop-Port™ again, the previously transferred images in the internal memory are deleted.

■ Switching the power on and off

Press and hold **1** on the main unit to switch on the Nokia Image Viewer.

Press and hold **1** to switch off the power.

Note that you cannot switch the power on or off with the remote control.

3. Using the Nokia Image Viewer

■ Nokia Image Viewer memory and picture formats

The Nokia Image Viewer supports JPEG and GIF format images with a maximum size of 1600 * 1200 pixels. The Nokia Image Viewer scales the images so that they fit optimally on the TV screen.

The Nokia Image Viewer can show images stored either in an MMC card or in a connected phone. When phone memory is selected, the Nokia Image Viewer transfers the images from a phone folder called **SU-5**, and, if no such folder is found, from your phone's default image folder. Depending on your phone model and the selected language of the phone, this default folder is shown differently on the phone's side. See your phone's user guide for the exact name and location of the default image folder. When MMC memory is selected, the Nokia Image Viewer

transfers the images from the root directory, from the "Images" folder, and from the "DCF" folder of the MMC. When you store images from a phone in the MMC card in the Nokia Image Viewer, the images are stored in the "Images" folder, or, if no such folder is found, in the root directory. Although the Nokia Image Viewer scales images before displaying them, it saves them to the MMC card in their original format.

When you want to view images from a phone, the Nokia Image Viewer transfers images from the phone and stores them in an internal buffer memory. If the buffer memory is unable to hold all the images, the Nokia Image Viewer automatically recycles the images in the buffer memory. This means that all the images in the phone can be displayed, even if they all cannot be stored in the buffer memory at the same time. If the phone is disconnected, you can continue viewing the images stored in the buffer memory until a phone is reconnected or the Nokia Image Viewer is switched off. All images in the buffer memory are discarded when the image viewer is turned off or a phone is connected.

■ Before using the Nokia Image Viewer

Before you start using the Nokia Image Viewer, check the following on your TV, phone and Nokia Image Viewer:

TV:

1. Your TV is switched on and you have selected the RCA input channel.
2. If you have a wide screen TV set, the TV screen should be set to a 4/3 ratio.
3. The RCA cable of the Nokia Image Viewer is connected to the RCA connector on your TV.

Phone:



1. Your phone is switched on.
2. The Nokia Image Viewer is connected to your compatible phone's Pop-Port™.

Each time you connect a phone to the Nokia Image Viewer, a progress bar is displayed on the TV while the images are transferred from the phone. While the progress bar is displayed, pressing any of the buttons on the main unit or the remote control will have no effect.

Nokia Image Viewer:

1. The Nokia Image Viewer is switched on and the Nokia logo is displayed on your TV screen.
2. If you are using the remote control, it must be within a maximum of 7 meters of the main unit and there must be no obstructions, between the IR ports of the main unit and the remote control.

■ Selecting the memory

The icon at the left bottom corner of the TV screen shows which memory is selected. The phone memory () means that you can view the images in the connected phone. The MMC memory () means that you can view the images in the MMC card inserted in the Nokia Image Viewer.







When you switch the Nokia Image Viewer on, it chooses phone memory by default. If no phone is connected, the Nokia Image Viewer attempts to switch to MMC memory. If no MMC card is inserted in the image viewer, and there is still no phone connected, the  icon is displayed.



To change which memory you use, press  on the remote control or press and hold  on the main unit.

■ Viewing images





You can display one image at a time or a set of images as a slide show.

Viewing one image at a time:



1. If a slide show is on, stop it by pressing  on the remote control or pressing and holding  on the main unit.
2. Press  or  on the remote control to scroll through the images and select the image you want to view. If you press and hold  or , the images scroll automatically.

If you are using the main unit, press  to scroll forward. Note that if you press and hold , the images do not scroll, as the memory changes instead.

Viewing the slide show:

1. To start a slide show, press  on the remote control or press and hold  on the main unit.
2. The images in the slide show change every 4 or 8 seconds. To change the interval, press and hold  on the remote control. You cannot change the interval from the main unit.
3. To stop the slide show, press  on the remote control or press and hold  on the main unit.

■ Rotating images



You can rotate the image displayed on the TV screen. If a slide show is on, wait until the image you want to rotate is displayed. If a slide show is not on, press  or  on the remote control or  on the main unit, until the image is displayed.

To rotate the image 90° clockwise, press  on the remote control or the main unit.

■ Saving images

When phone memory is selected, you can save images from a phone to the MMC card inserted in the Nokia Image Viewer.

Saving one image:

If a slide show is on, wait until the image you want to save is displayed. If a slide show is not on, press  or  on the remote control or  on the main unit, until the image is displayed.

Press  on the remote control or the main unit to save the image.

Saving an entire slide show:



Press and hold  on the remote control or the main unit to save all the images in the slide show. Note that the slide show must be on. If the slide show is not on, only the displayed image is saved.



Before saving the images, the Nokia Image Viewer checks that the MMC card has room for them. If the entire slide show does not fit in the MMC card, the  icon is displayed and none of the images are saved.

■ Deleting images

When phone memory is selected, you can delete an image from the Nokia Image Viewer's internal buffer memory, not from the phone. When the image is deleted from the buffer memory, it is not displayed anymore.

When MMC memory is selected, you can delete an image directly from the MMC card inserted in the Nokia Image Viewer.

If a slide show is on, wait until the image you want to delete is displayed. If a slide show is not on, press  or  on the remote control or  on the main unit, until the image is displayed.

Press and hold  on the remote control or the main unit, until the  icon is displayed.

Care and maintenance

Treat your Nokia Image Viewer with care. The suggestions below will help you to enjoy the product for many years.

- Keep all enhancements out of the reach of small children.
- Use the Nokia Image Viewer indoors only.
- Do not drop, knock or shake the Nokia Image Viewer. Rough handling can break internal circuit boards.
- Do not use harsh chemicals, cleaning solvents, or strong detergents to clean the Nokia Image Viewer.

If the Nokia Image Viewer is not working properly, take it to your nearest qualified service facility.